

Fig. 16

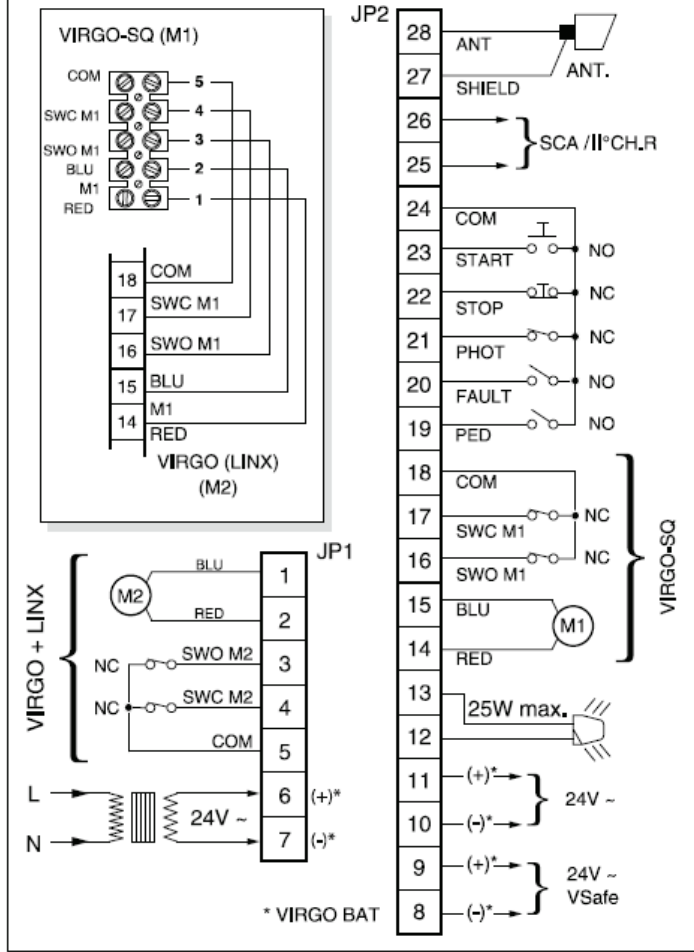

Fig. 17

